

| REVISIONS | | | |
|-----------|-------------|------|----|
| REV | DESCRIPTION | DATE | BY |
| | | | |

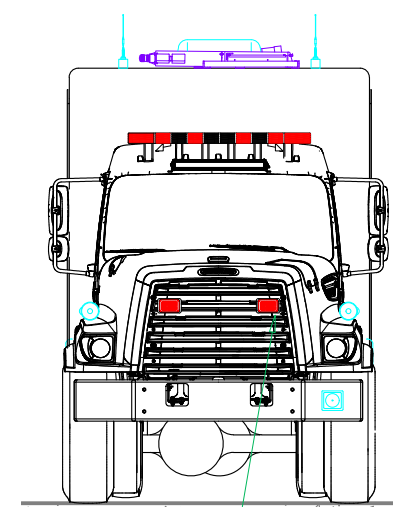

TWO (2) WHELEN 600
RED LED - BLACK

163 1/4"
[13'-7"]
OAH (SEE NOTE 2)

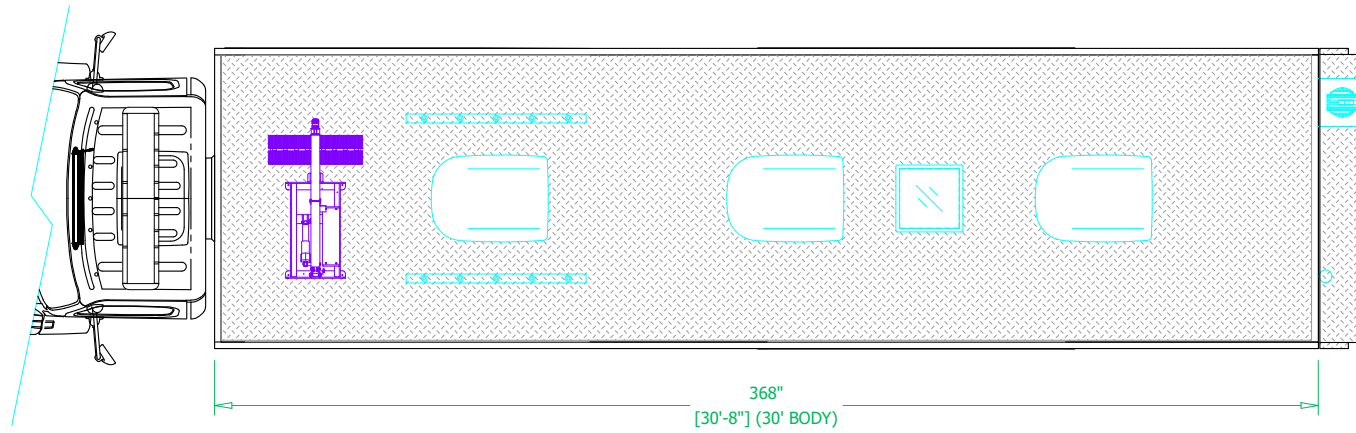
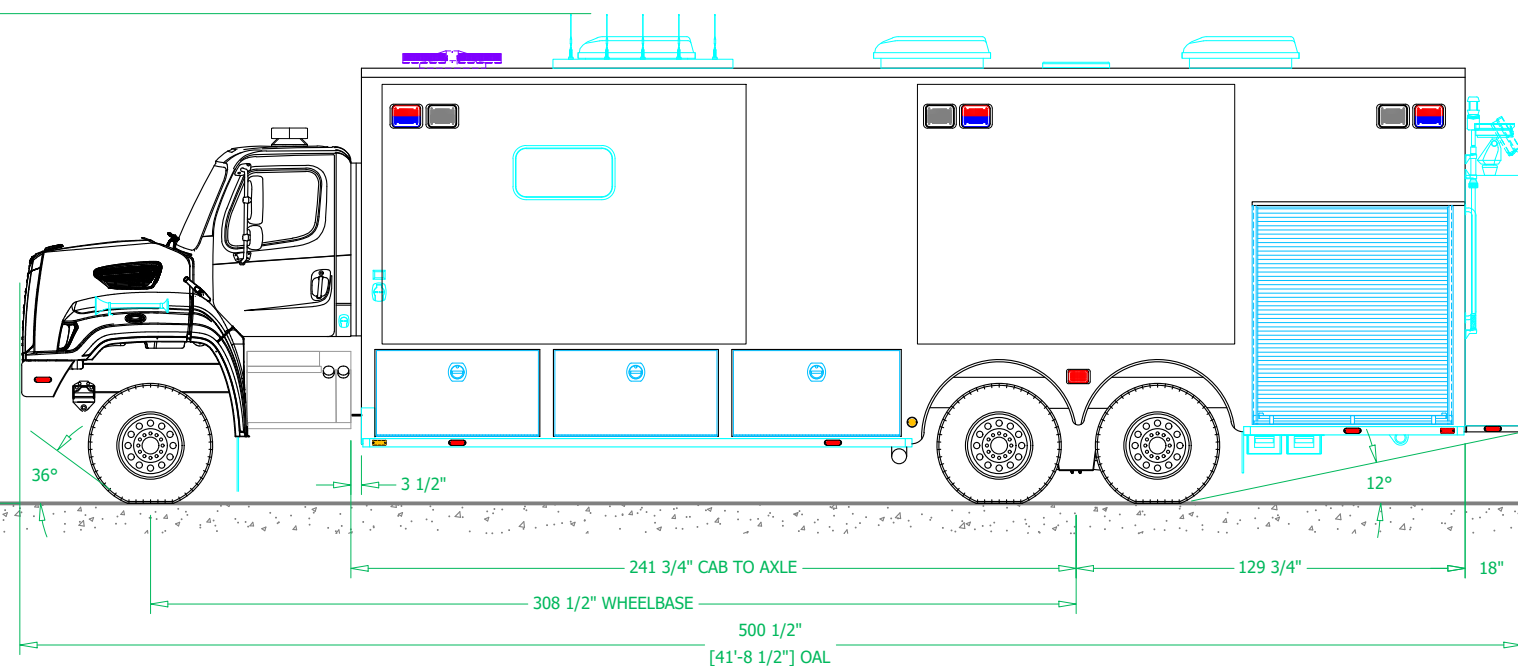

FOUR (4) WHELEN 600
RED LED - BLACK
TWO (2) EACH SIDE

SIX (6) WHELEN 900
SCENE - BLACK
THREE (3) EACH SIDE

SIX (6) WHELEN 900
RED/BLUE LED - BLACK
THREE (3) EACH SIDE

TEN (10) WHELEN ION
RED LED - CHROME
FIVE (5) EACH SIDE

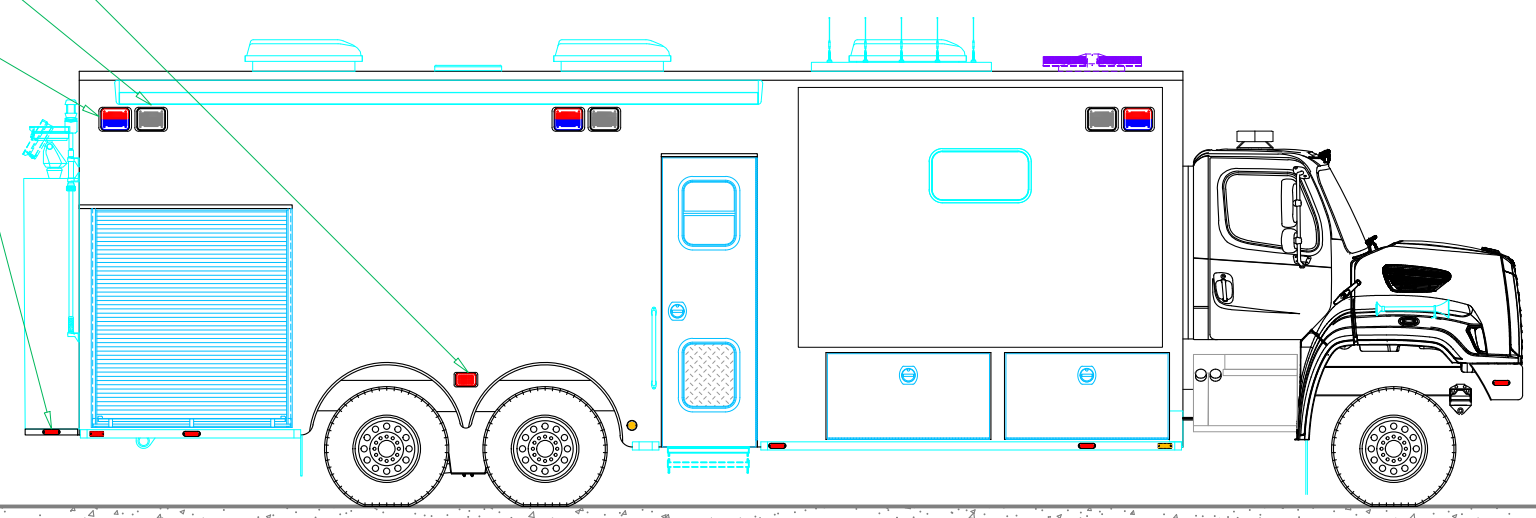

TWO (2) WHELEN 900
RED/BLUE LED - BLACK

TWO (2) WHELEN 900
SCENE - BLACK

EIGHT (8) WHELEN ION
AMBER LED - BLACK

-TWO (2) WHELEN 600
RED LED - WARNING

-TWO (2) WHELEN 600
AMBER LED - TURN

-TWO (2) WHELEN 600
RED LED - BRAKE

-TWO (2) WHELEN 600
CLEAR LED - BACK-UP

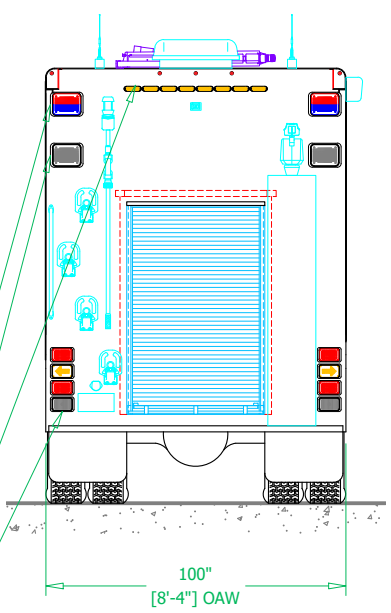



SVI FIRE & RESCUE TRUCKS
3842 REDMAN DRIVE, FORT COLLINS, CO 80524 PHONE 970-297-7100, FAX 970-297-7099

**BOULDER COUNTY
HAZMAT TEAM**

| | |
|-------------------------------|-------------------------------|
| BODY SIZE: 30' BODY | UNIT TYPE: COMMAND |
| BODY MATERIAL: 3/16" ALUMINUM | TRUCK NO: SVI #1267 |
| CHASSIS TYPE: FREIGHTLINER | WHEELBASE: SEE DWG |
| M2 108 SD | CAB TO AXLE: SEE DWG |
| FLAT | OVERALL LENGTH (OAL): SEE DWG |
| TWO DOOR | OVERALL WIDTH (OAW): SEE DWG |
| | OVERALL HEIGHT (OAH): SEE DWG |

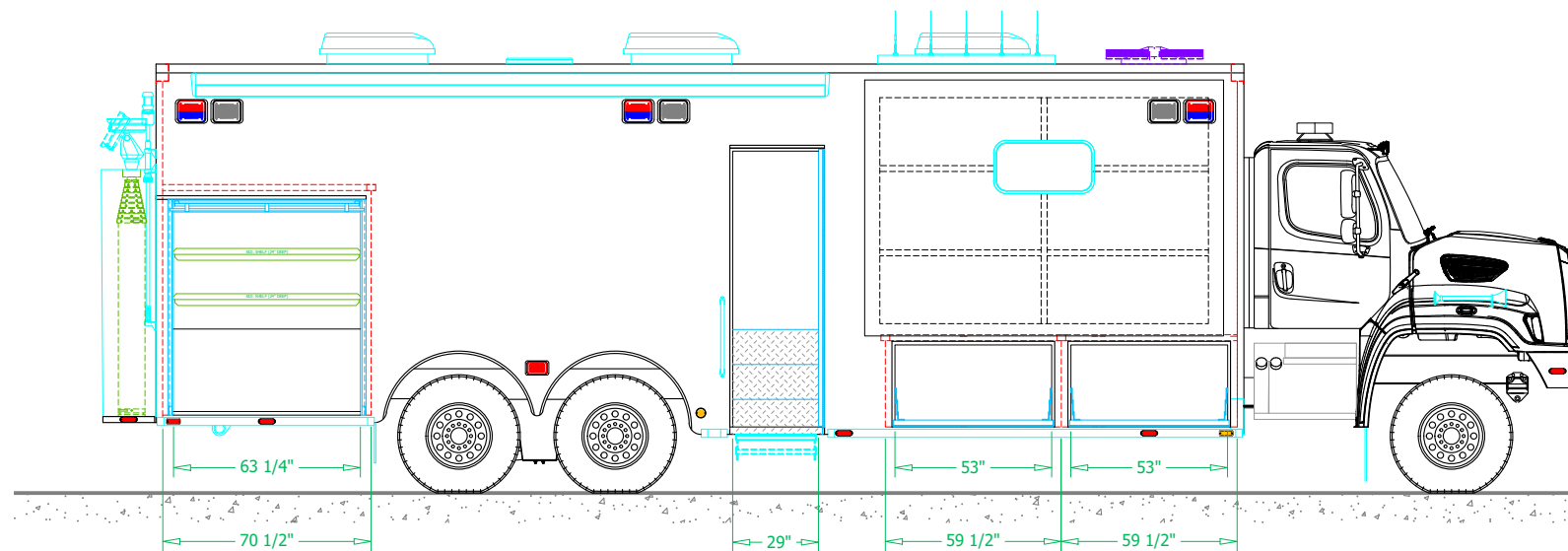
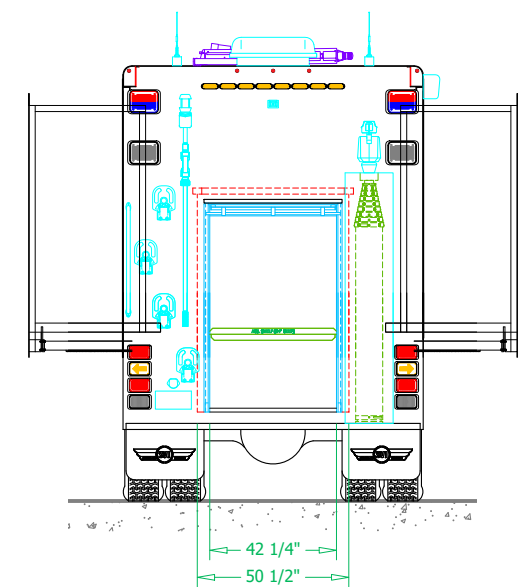
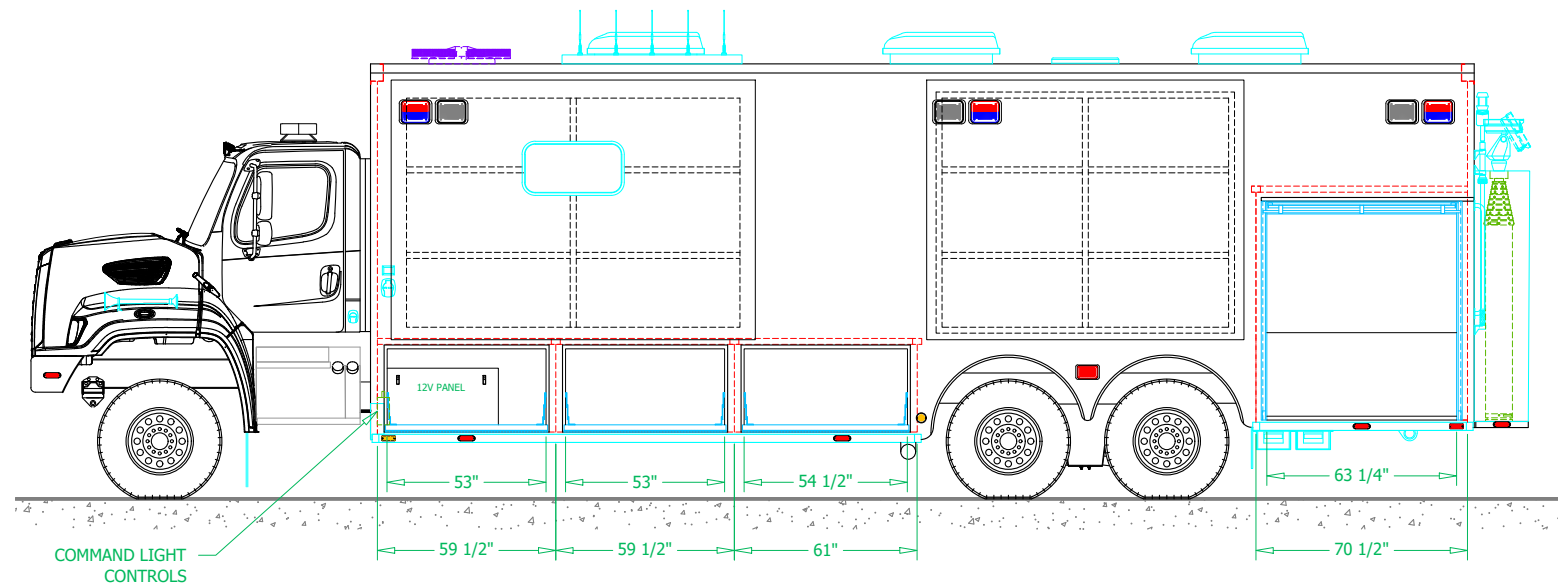
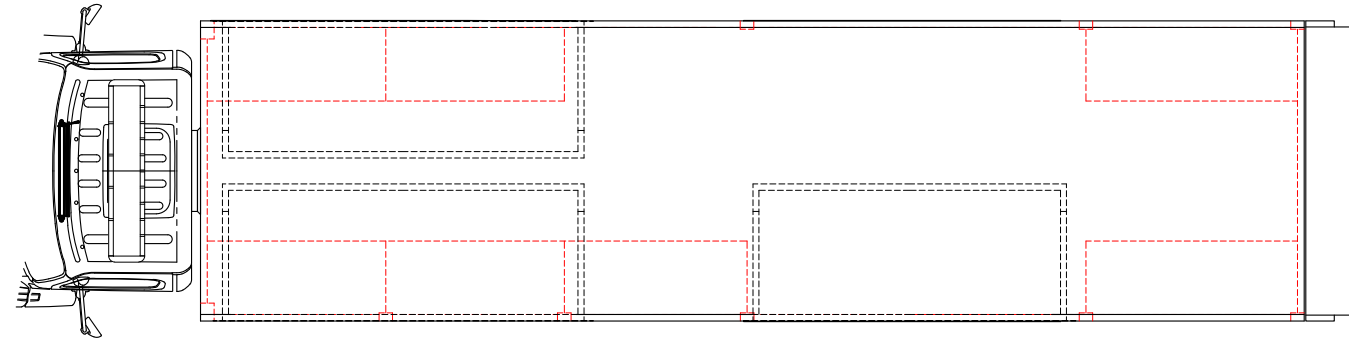
| REVISIONS | | | |
|-----------|-------------|------|----|
| REV | DESCRIPTION | DATE | BY |
| | | | |





SVI FIRE & RESCUE TRUCKS
3842 REDMAN DRIVE, FORT COLLINS, CO 80524 PHONE 970-297-7100, FAX 970-297-7099

**BOULDER COUNTY
HAZMAT TEAM**

| | | |
|---|-----------------------|----------------------|
| DRAWN BY: KP | DATE: January 9, 2023 | SCALE: 3/16" = 1'-0" |
| DRAWING NO: BoulderCounty CO HZMT PreCon1 | | SHEET 2 OF 3 |

| REVISIONS | | | |
|-----------|-------------|------|----|
| REV | DESCRIPTION | DATE | BY |
| | | | |

PLAN VIEW
CROSS-SECTION

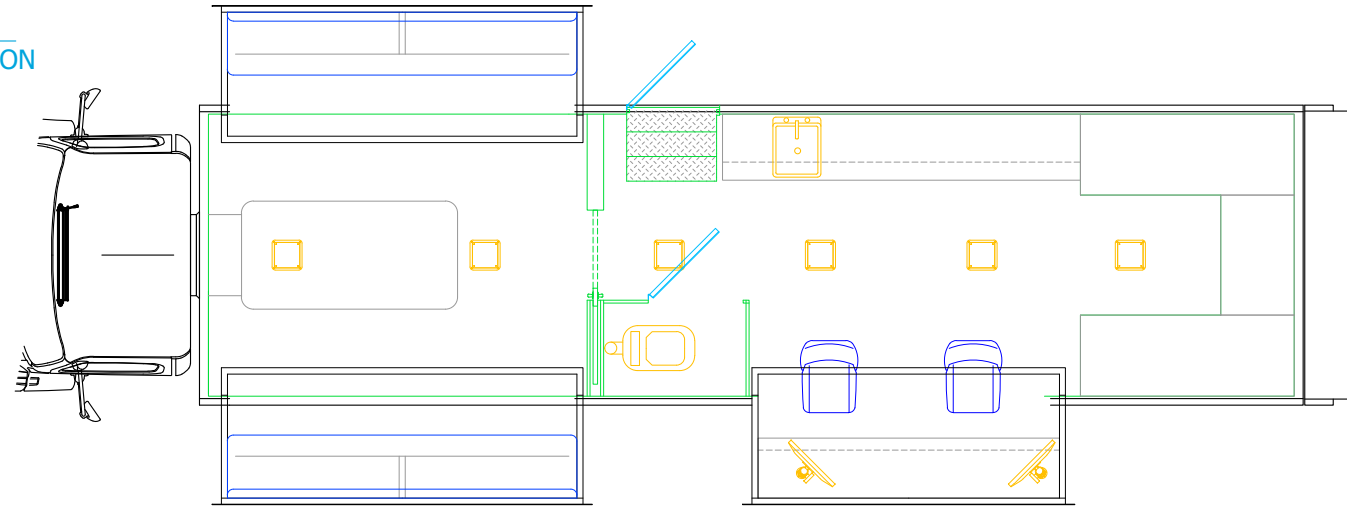

SLIDEOUTS
CROSS-SECTION

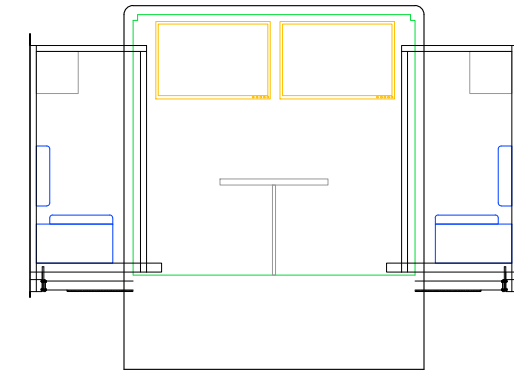

INTERIOR STORAGE
CROSS-SECTION

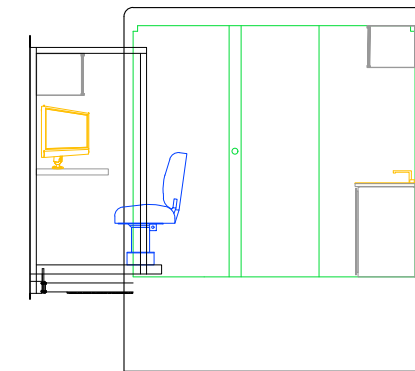

CURBSIDE INTERIOR
CROSS-SECTION

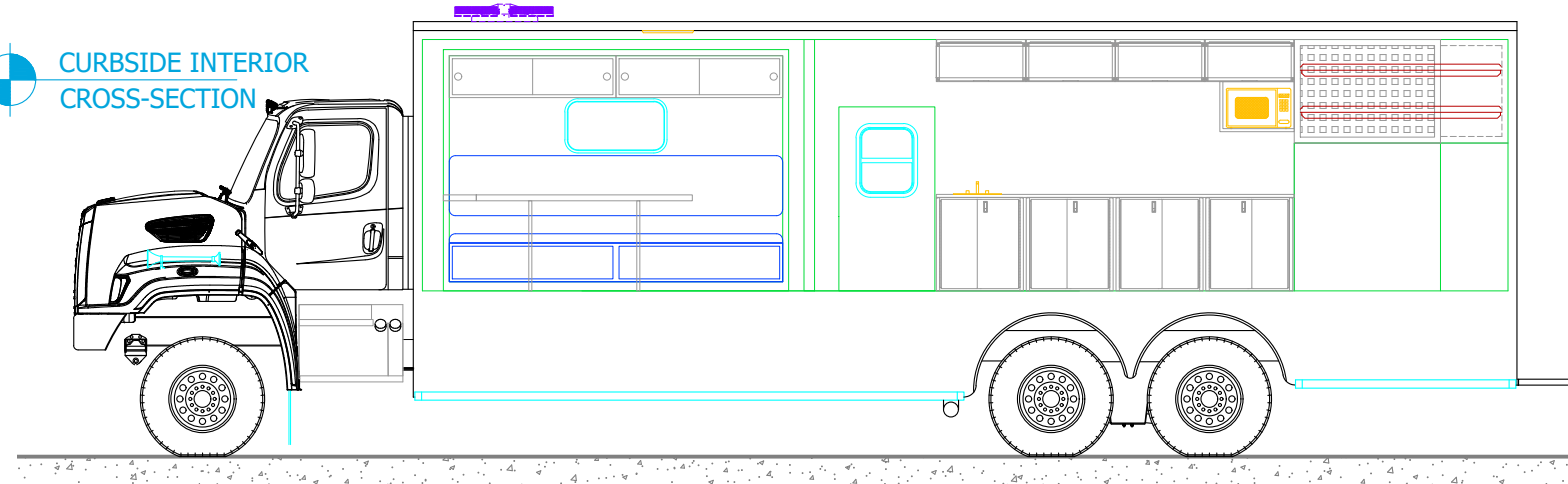

STREETSIDE INTERIOR
CROSS-SECTION

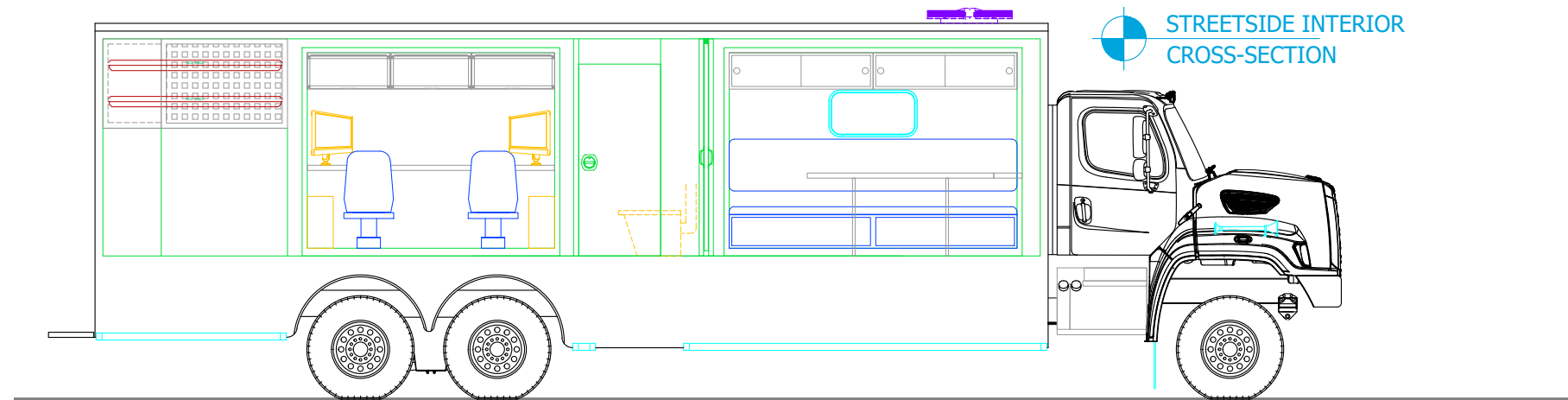

SVI FIRE & RESCUE TRUCKS
3842 REDMAN DRIVE, FORT COLLINS, CO 80524 PHONE 970-297-7100, FAX 970-297-7099

**BOULDER COUNTY
HAZMAT TEAM**