

REVISIONS			
REV	DESCRIPTION	DATE	BY

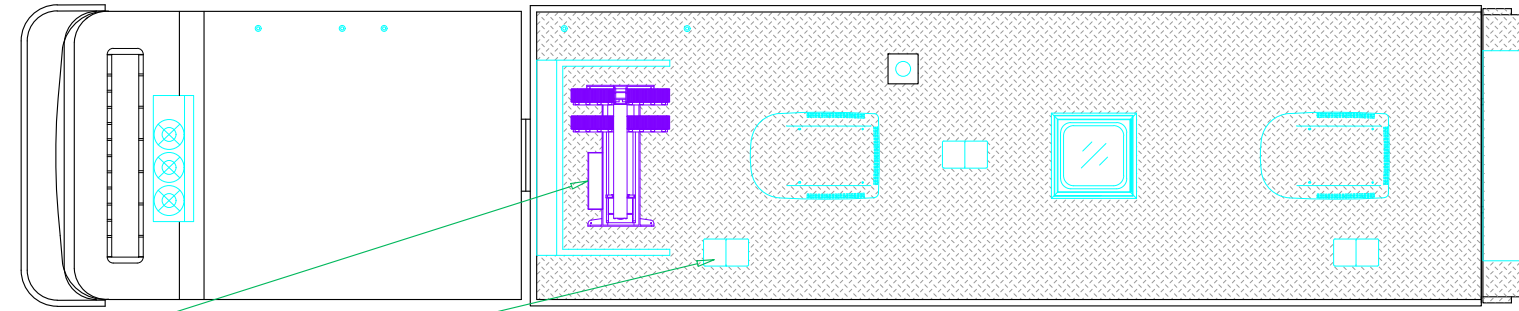

KNIGHT LIGHT
KL415A-FX4 (4-LED)
LIGHT-TOWER

THREE (3) FANTASTIC
6000RTBA CEILING-VENTS

317"
[26'-5"]

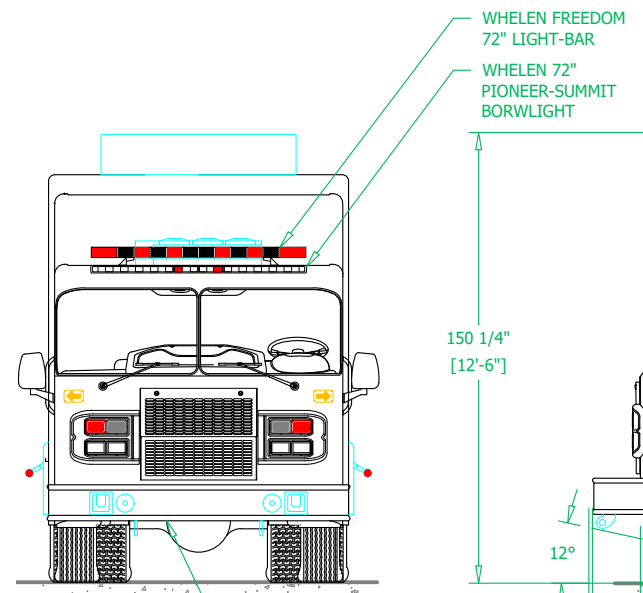

WHELEN FREEDOM
72" LIGHT-BAR

WHELEN 72"
PIONEER-SUMMIT
BORWLIGHT

150 1/4"
[12'-6"]

12°

16"

BUMPER COMPONENTS
-TWO (2) GROVER AIR-HORNS
INBOARD (CS & SS)

-TWO (2) CAST PRODUCT
SIREN SPEAKERS - SA4301
OUTBOARD (CS & SS)

- TWO EYES
UNDER-BUMPER

FOUR (4) FIRE SPECTRA MAX
SCENE/FLOOD LIGHT - CHROME
TWO (2) EACH SIDE

TWO (2) BRITAX 427
RED LED
ONE (1) EACH SIDE

TWELVE (12) WHELEN 600
RED LED - CHROME
SIX (6) EACH SIDE

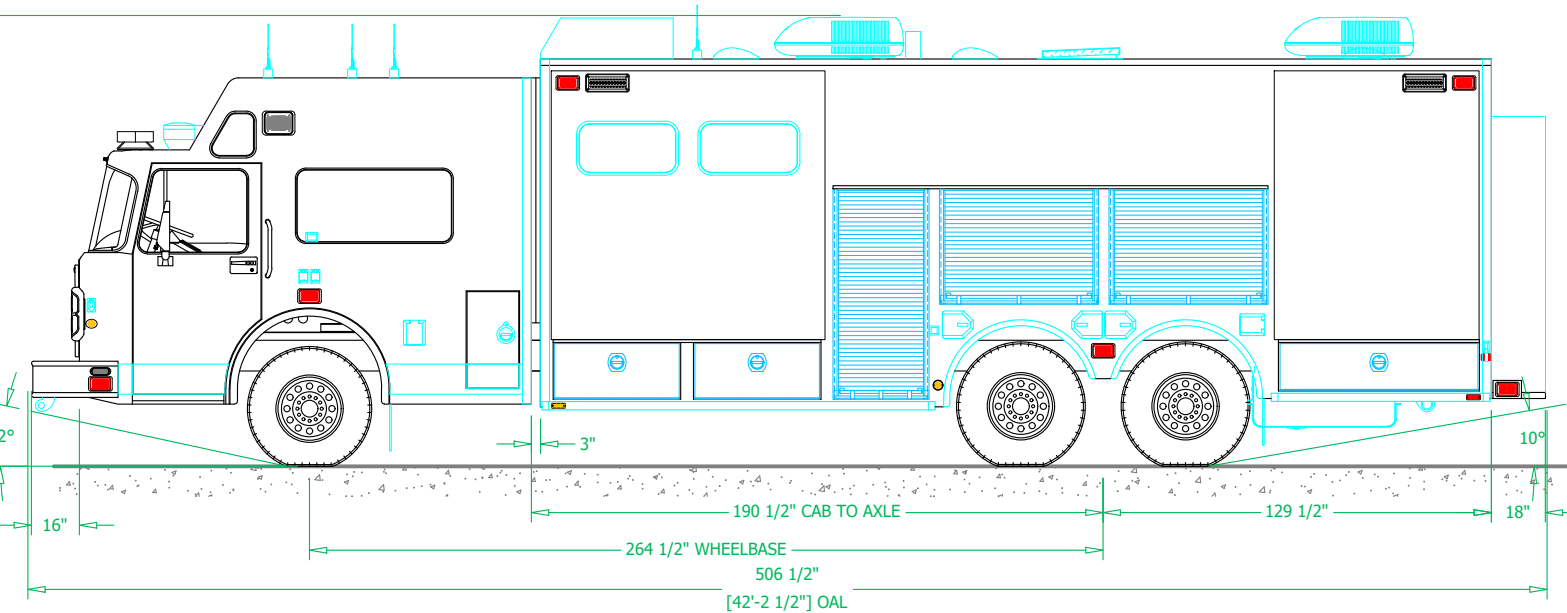

190 1/2" CAB TO AXLE

264 1/2" WHEELBASE

506 1/2"

[42'-2 1/2"] OAL

EIGHT (8) WHELEN ION
AMBER LED - CHROME
TRAFFIC ADVISOR

SIX (6) WHELEN 600
RED LED - CHROME

TWO (2) WHELEN 900
SCENE LIGHT - CHROME

WHELEN 72"
PIONEER-SUMMIT
(DISCONNECTED
MARKER-LIGHTS)

-TWO (2) WHELEN 900
RED LED - BRAKE

-TWO (2) WHELEN 900
AMBER LED - TURN

-TWO (2) WHELEN 900
CLEAR LED - BACK-UP

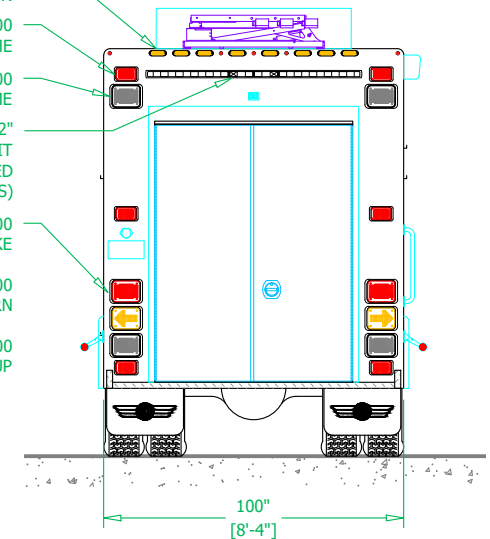

100"
[8'-4"]

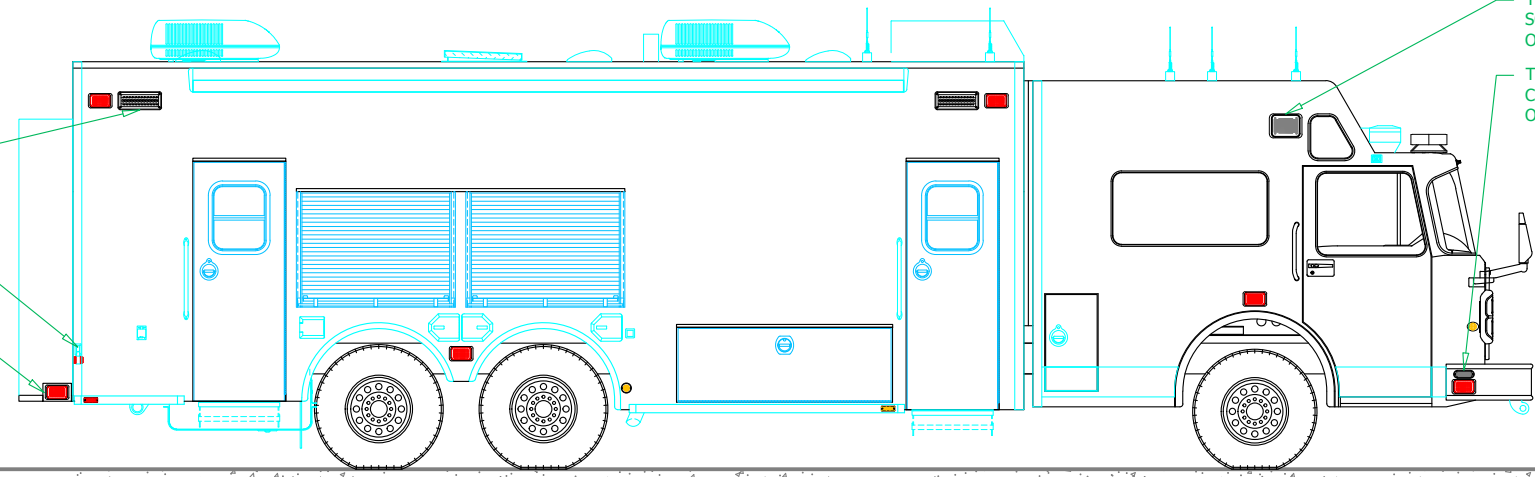

TWO (2) WHELEN 900
SCENE LIGHT - CHROME
ONE (1) EACH SIDE

TWO (2) WHELEN 500
CLEAR LED - CHROME
ONE (1) EACH SIDE



SVI FIRE & RESCUE TRUCKS
3842 REDMAN DRIVE, FORT COLLINS, CO 80524 PHONE 970-297-7100, FAX 970-297-7099

**EDMONTON
DANGEROUS GOODS UNIT**

BODY SIZE: 26' TANDEM BODY	UNIT TYPE: HAZMAT
BODY MATERIAL: 3/16" ALUMINUM	TRUCK NO: SVI #1260
CHASSIS TYPE: SPARTAN	WHEELBASE: 264.50"
GLADIATOR - ELFD	CAB TO AXLE: 190.50"
24" RR	OVERALL LENGTH (OAL): 506.50"
TWO DOOR	OVERALL WIDTH (OAW): 100.00"
	OVERALL HEIGHT (OAH): 150.00"

REVISIONS			
REV	DESCRIPTION	DATE	BY

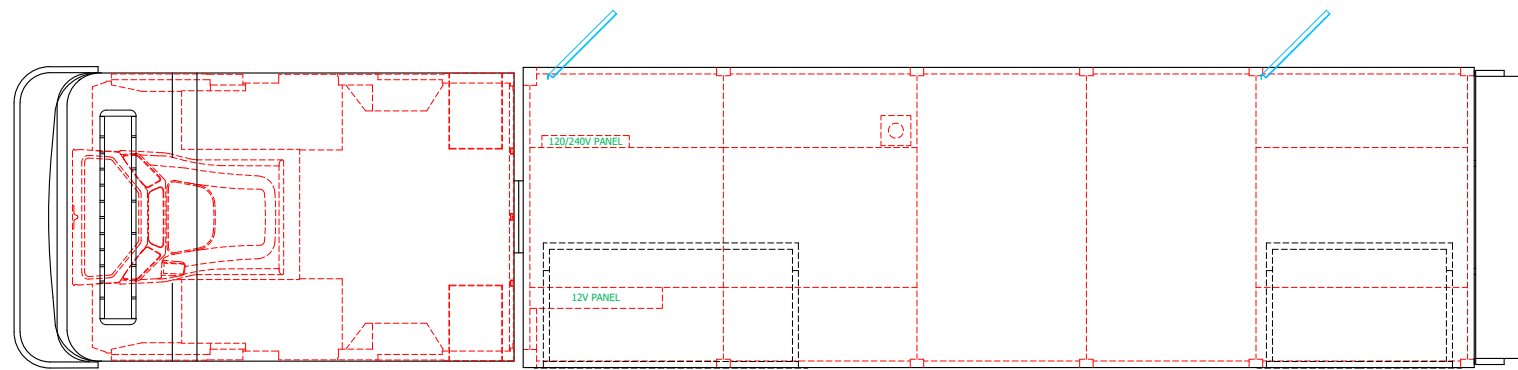

TWO (2) COLEMAN MACH 3 HVAC
 FIVE (5) ANTENNAS
 DEF-FILL

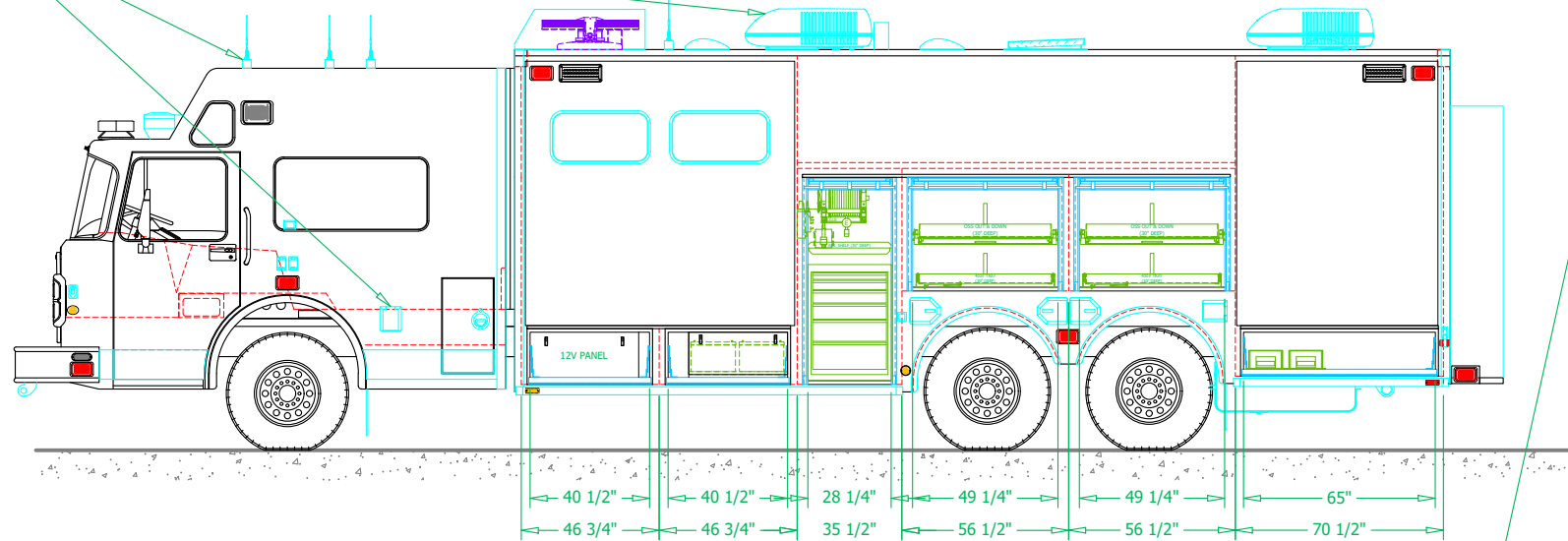

AUDIOVOX VOYAGER
 REARVIEW CAMERA
 LED LICENSE
 PLATE BRACKET
 AUDIOVOX VOYAGER
 REARVIEW CAMERA

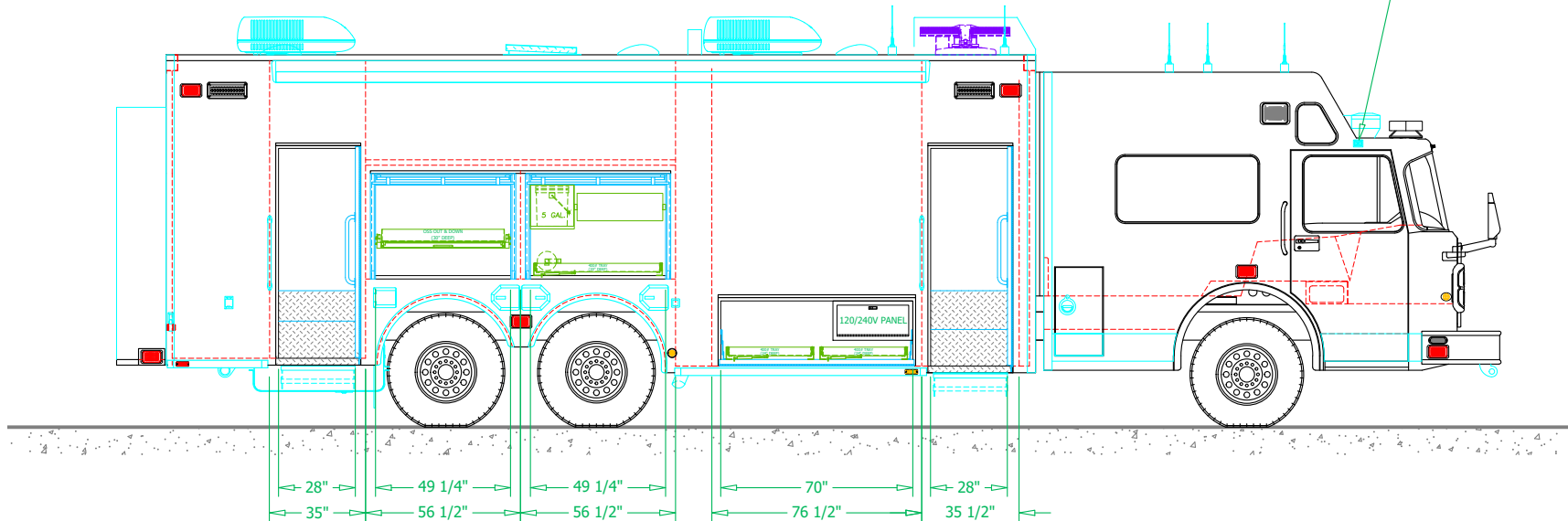
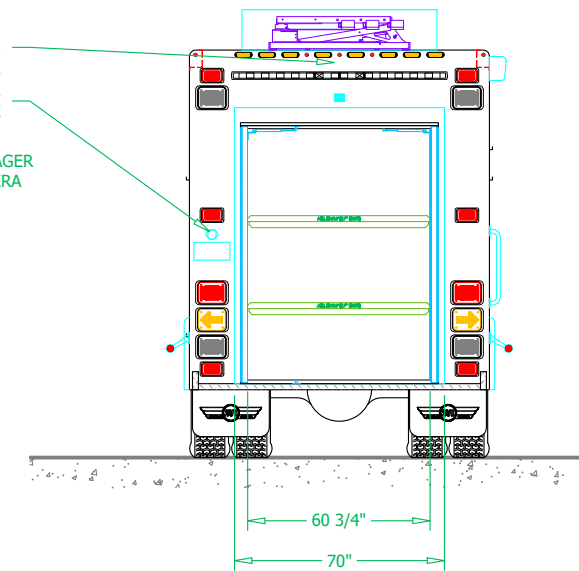

SVI FIRE & RESCUE TRUCKS
 3842 REDMAN DRIVE, FORT COLLINS, CO 80524 PHONE 970-297-7100, FAX 970-297-7099

**EDMONTON
 DANGEROUS GOODS UNIT**

REVISIONS			
REV	DESCRIPTION	DATE	BY

PLAN VIEW
CROSS-SECTION

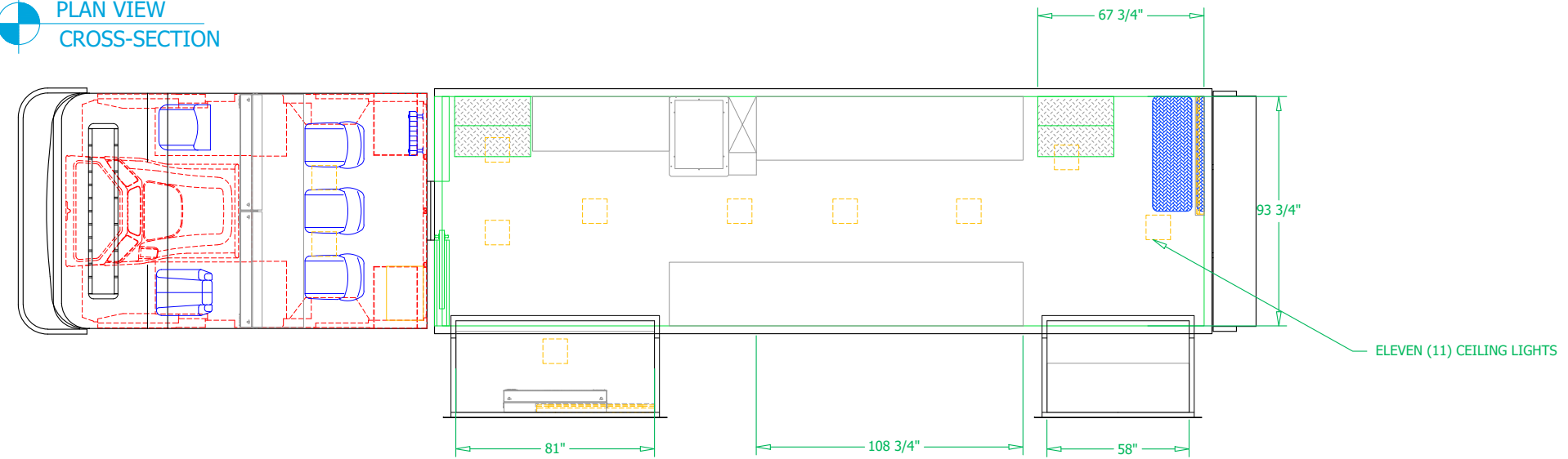

CAB WALK-IN
CROSS-SECTION

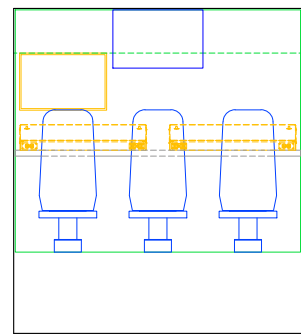

CURBSIDE INTERIOR
CROSS-SECTION

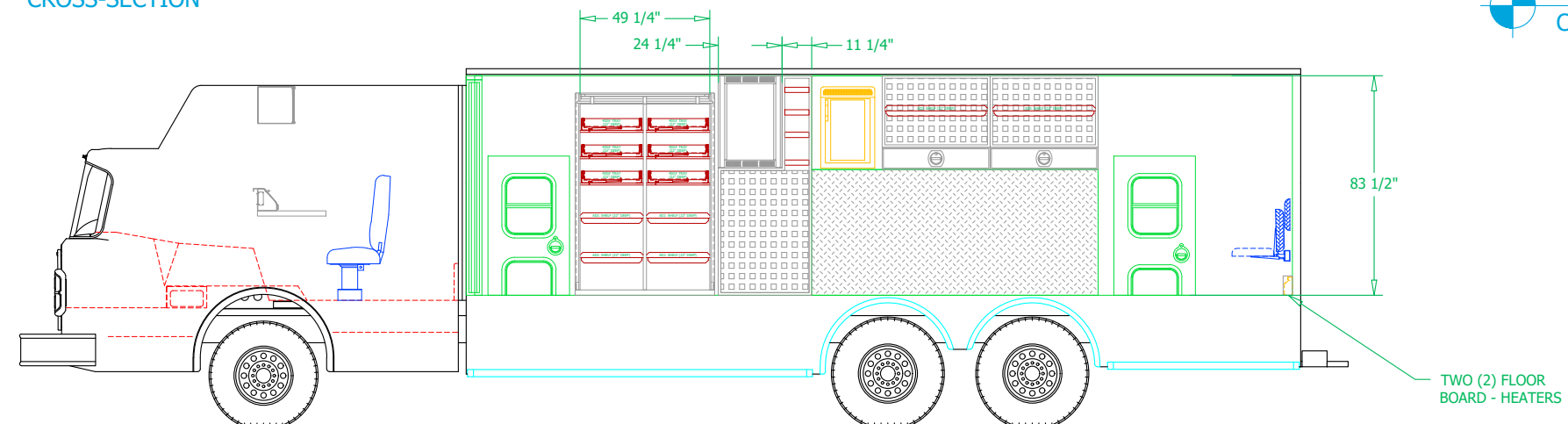

FRONT WALK-IN
CROSS-SECTION

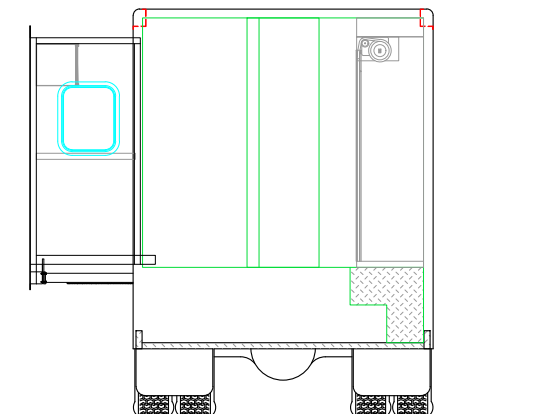

STREETSIDE INTERIOR
CROSS-SECTION

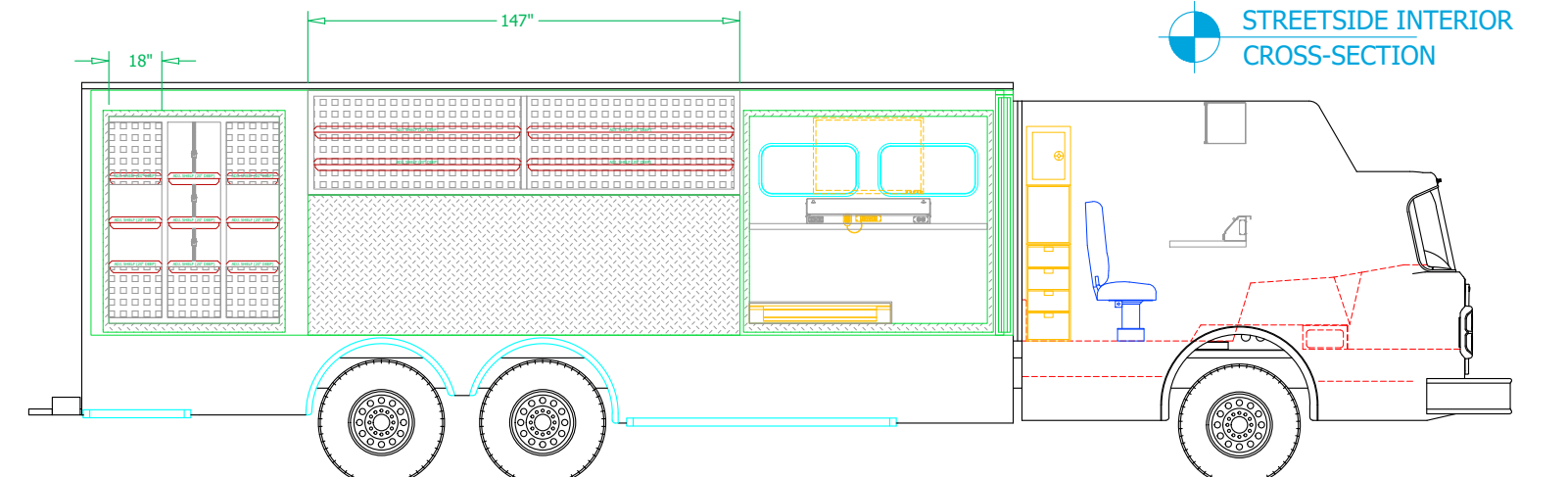



SVI
FORT COLLINS COLORADO

SVI FIRE & RESCUE TRUCKS
3842 REDMAN DRIVE, FORT COLLINS, CO 80524 PHONE 970-297-7100, FAX 970-297-7099

EDMONTON
DANGEROUS GOODS UNIT

DRAWN BY: KP	DATE: April 25, 2023	SCALE: 3/16" = 1'-0"
DRAWING NO: Edmonton_AB_hz26_PCM	SHEET 3 OF 3	